



Xorel Artform[®]
Product Specification Sheet



Xorel Artform[®]

Xorel Artform is a versatile acoustical panel system that combines the beauty and performance of Xorel textiles with proven sound absorbing capabilities to transform interior wall and ceiling spaces in form and function without disruption.

Wall/Ceiling Mounted and Horizontal Suspension Applications

SHAPES & SIZES

Arc

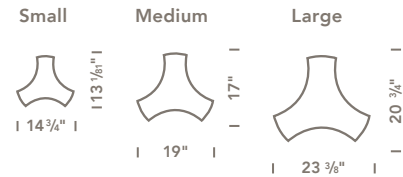

Circle / Circle 3D

Standard and 3D shapes share the same dimensions

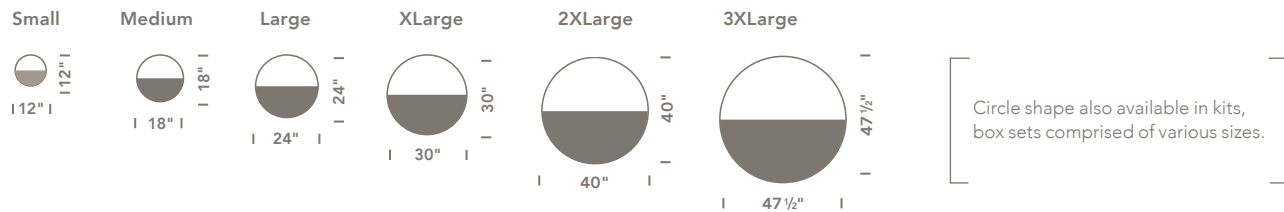

Criss

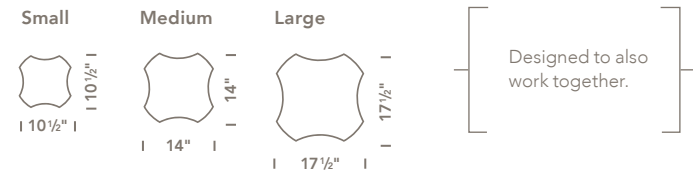

Cross



Diamond / Diamond 3D

Standard and 3D shapes share the same dimensions

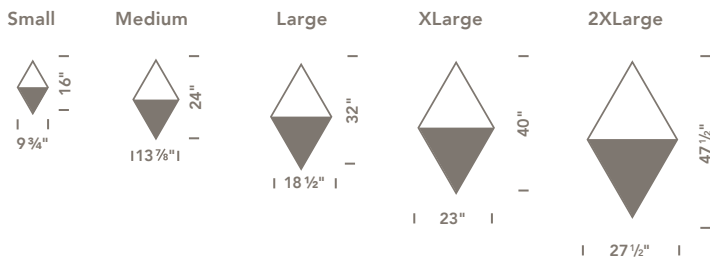

Flip

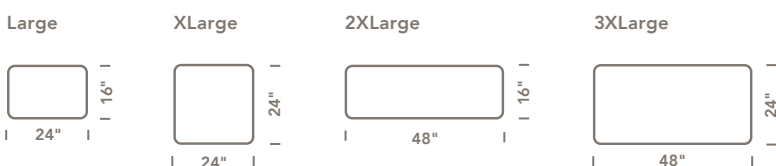

Wall/Ceiling Mounted and Horizontal Suspension Applications

SHAPES & SIZES

Hex / Hex 3D

Standard and 3D shapes share the same dimensions

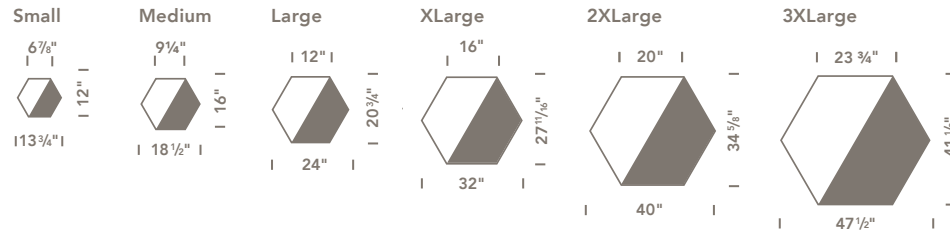

Peak

Peak A8

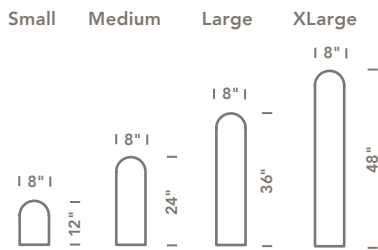

Peak A12

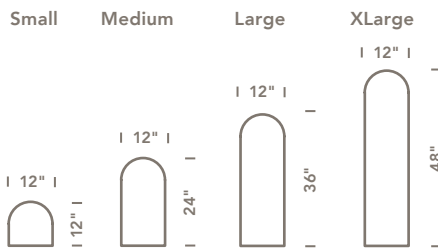

Peak B8

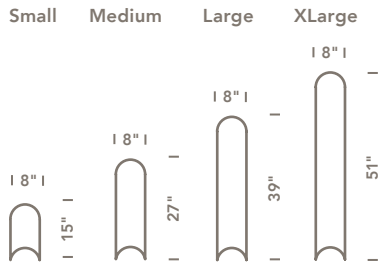

Peak B12

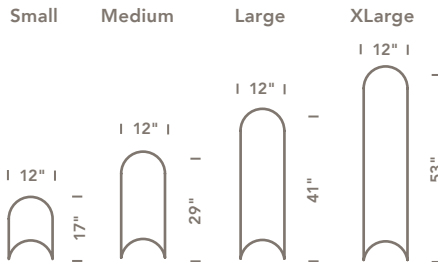

Peak C8

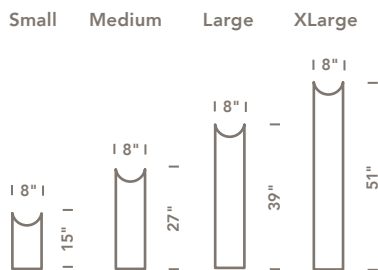

Peak C12

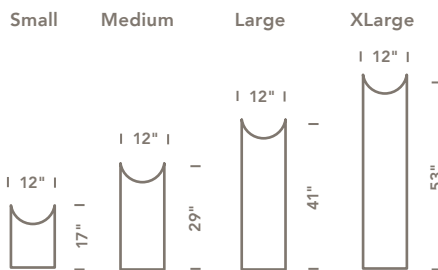

Peak D8

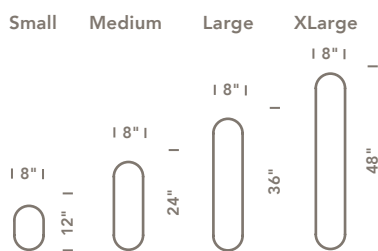

Peak D12

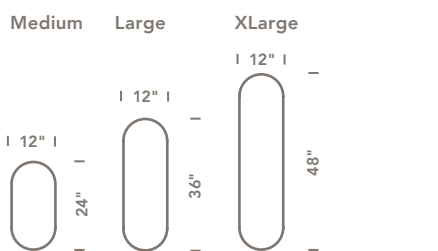

Wall/Ceiling Mounted and Horizontal Suspension Applications

SHAPES & SIZES

Plank

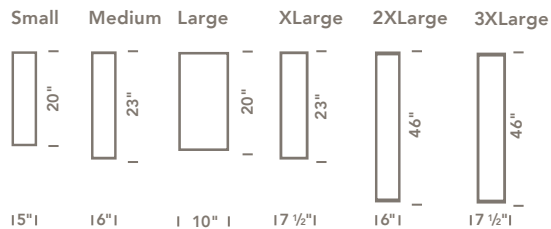

Ridge

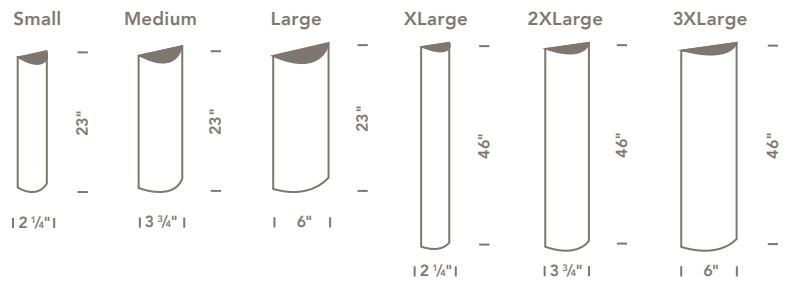

Ripple

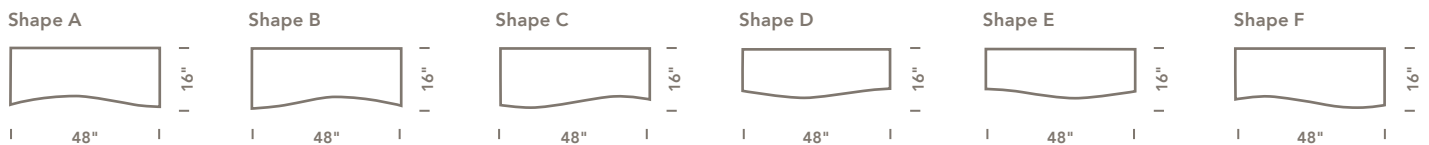

Scale

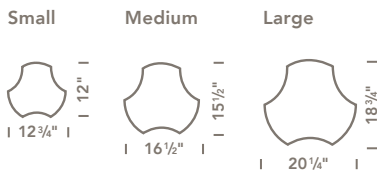

Square / Square 3D

Standard and 3D shapes share the same dimensions

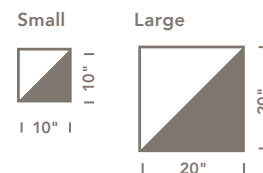

Tall Hex

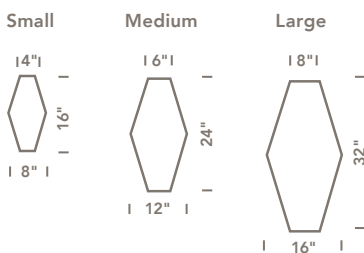

Valley

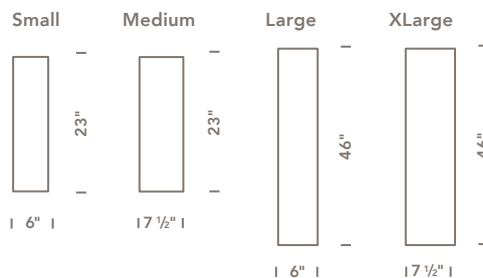

Waveline / Waveline 3D

Standard and 3D shapes share the same dimensions

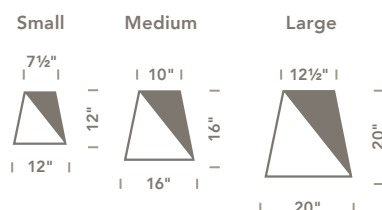

Vertical Suspension Application (Baffles)

SHAPES & SIZES

Circle

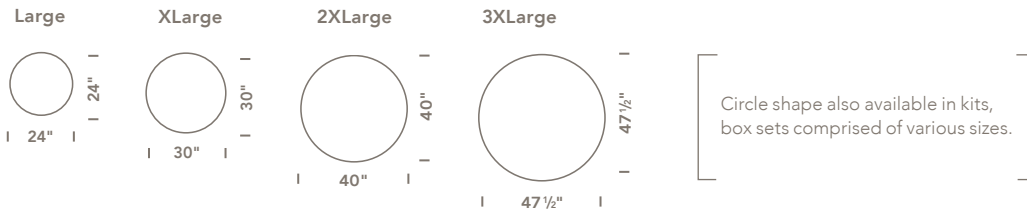

Diamond Vertical

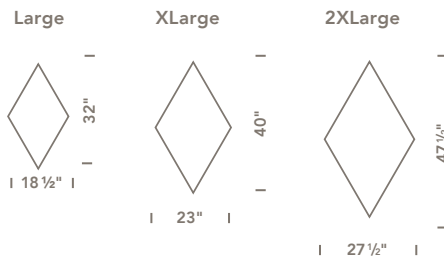

Diamond Horizontal

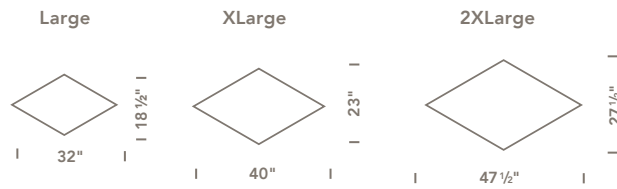

Flip

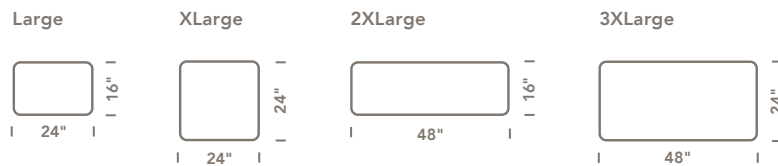

Hex

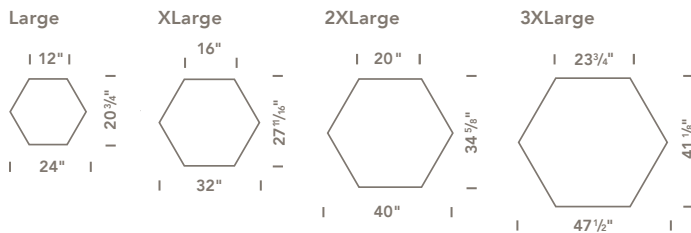

Ripple

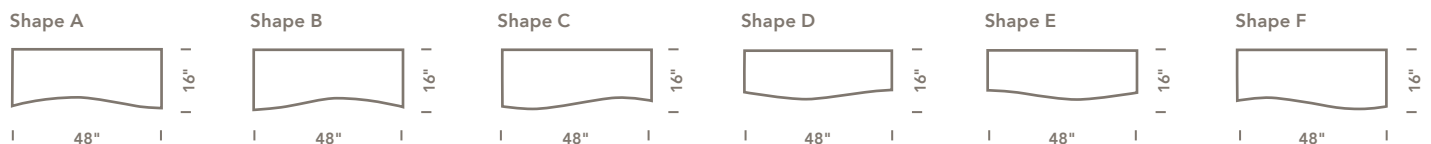

Dual-Sided Partition Application (Cascade)

SHAPES & SIZES

Circle Cascade

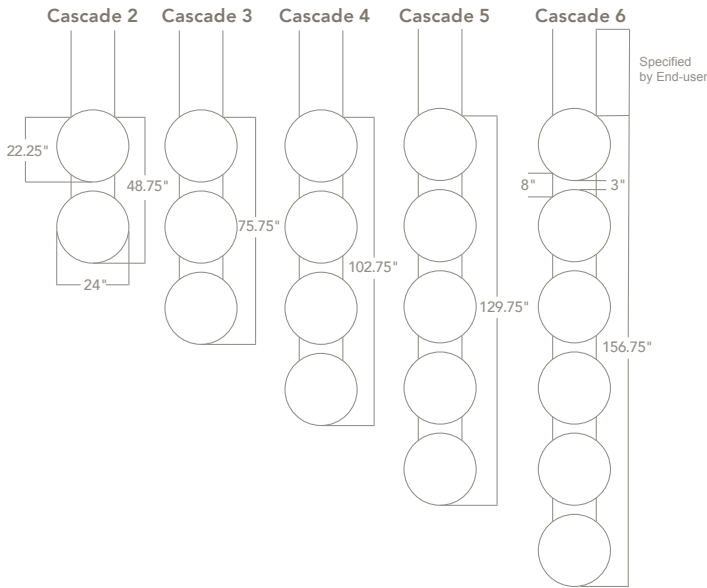

Hex Cascade

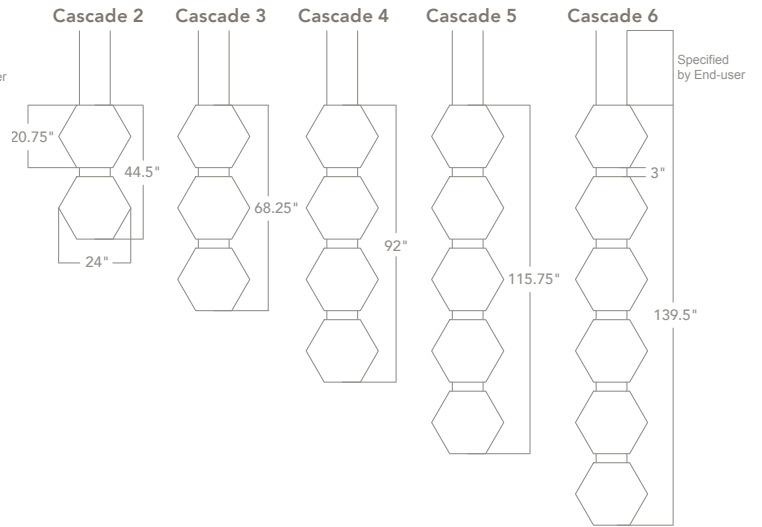

Flip L Cascade

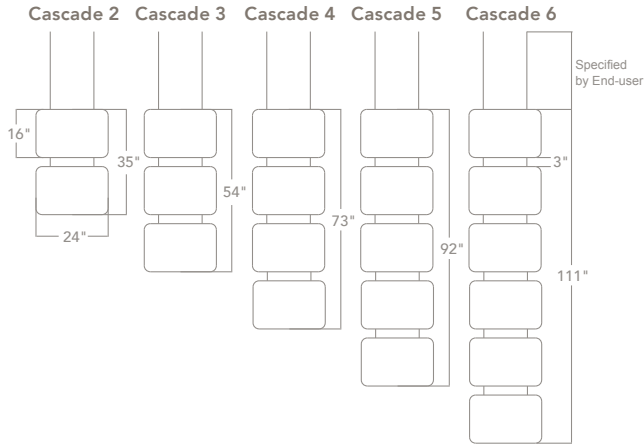

Diamond Cascade

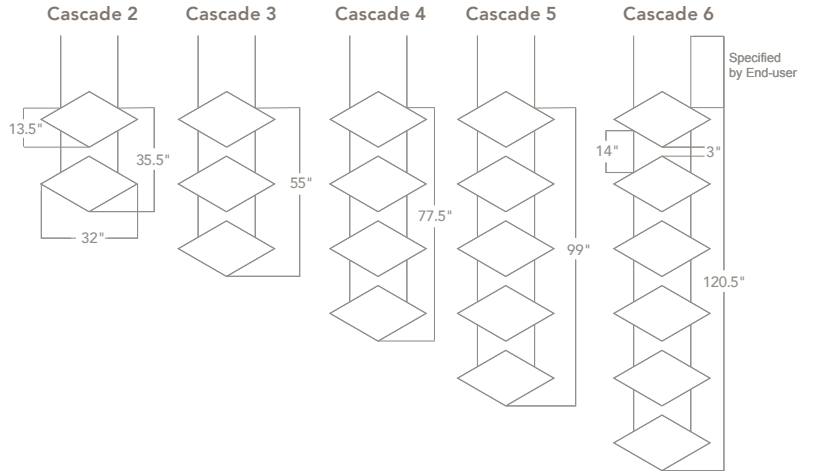

Flip 2XL Cascade

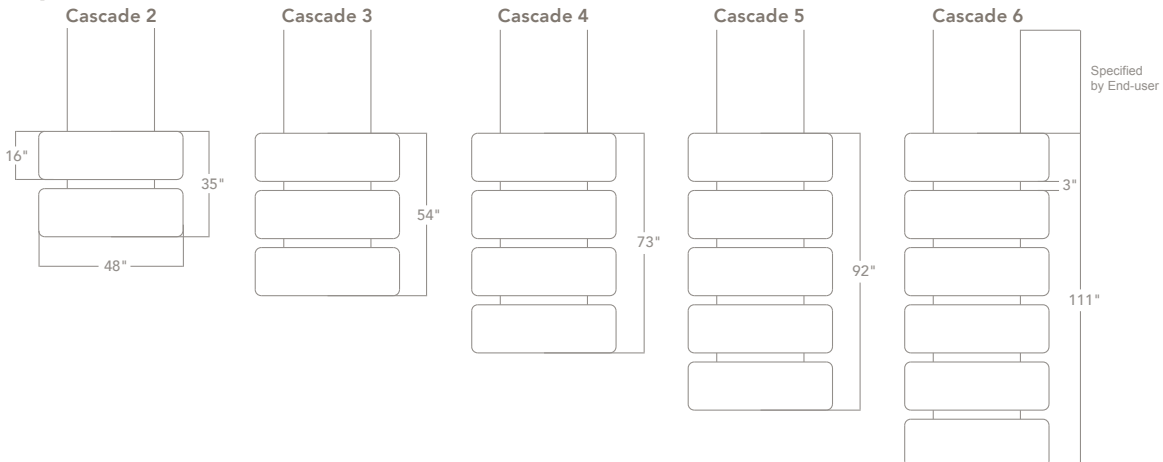

Dual-Sided Partition Application (Connect)

SHAPES & SIZES

Circle Connect

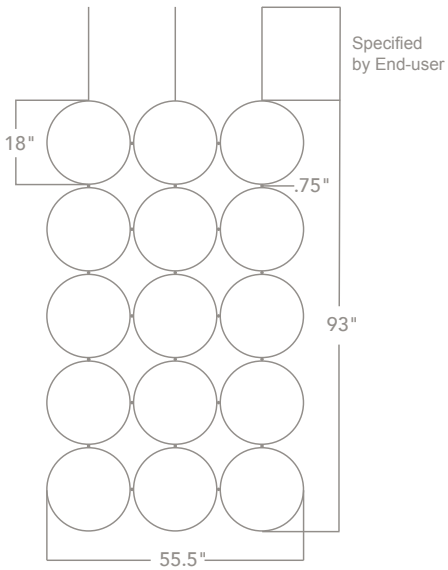

Hex Connect

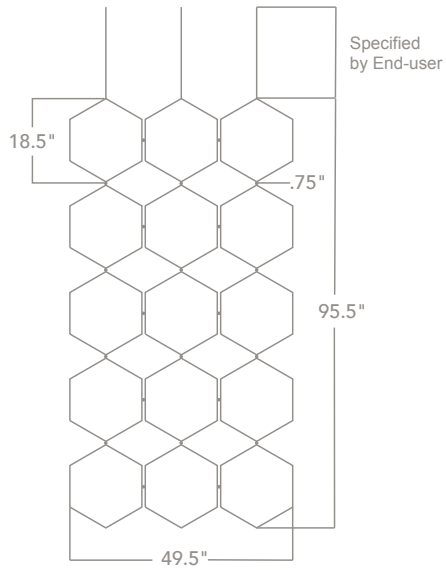

Diamond Connect

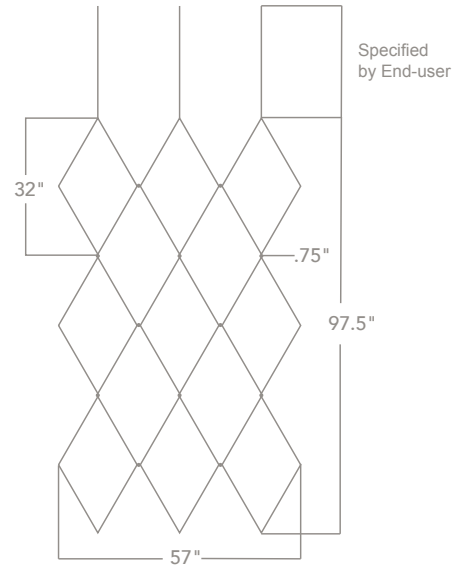

Substrate Options and Acoustical Performance

Xorel Artform is available in three substrates:
Quiet-Core™, Quiet-Core Plus™ and Mi-Core™

Quiet-Core™

This acoustical substrate is sound absorbing, formaldehyde-free and manufactured with 20% post-consumer recovered materials. It is available in a 1" thickness and used for all 3D shapes. It meets ASTM E84 Class A/Class 1.

Not recommended as a tackable surface.

Acoustical Performance

250Hz	500Hz	1000Hz	2000Hz	4000Hz	NRC
.25	.84	1.06	1.03	.99	.80

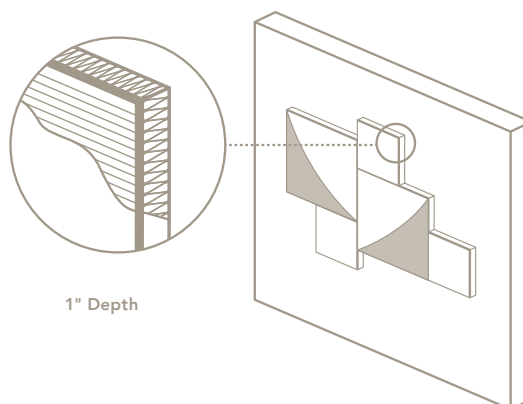

Quiet-Core Plus™

Quiet-Core Plus is a tackable and acoustical solution. Constructed with a 1/8" high density substrate of inorganic minerals & wool blend fastened to the face of the standard Quiet-Core panel. **This substrate provides tackability (all 3D shapes are not tackable) and exceptional acoustical**

Acoustical Performance

250Hz	500Hz	1000Hz	2000Hz	4000Hz	NRC
.53	1.07	.92	.68	.55	.80

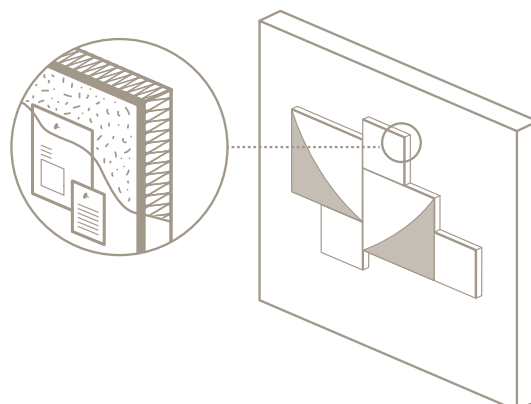

Mi-Core™

This **tackable** substrate offers moderate acoustical properties. Mi-Core is constructed with inorganic minerals and fibers making it resistant to moisture and warping. **Mi-Core is a dense material recommended for high traffic areas.** It is available in 1/2" & 3/4" thickness. It meets ASTM E84 Class A/Class 1.

3D shapes are NOT available in Mi-Core Substrate.

Acoustical Performance

250Hz	500Hz	1000Hz	2000Hz	4000Hz	NRC
.18	.31	.36	.41	.46	.30

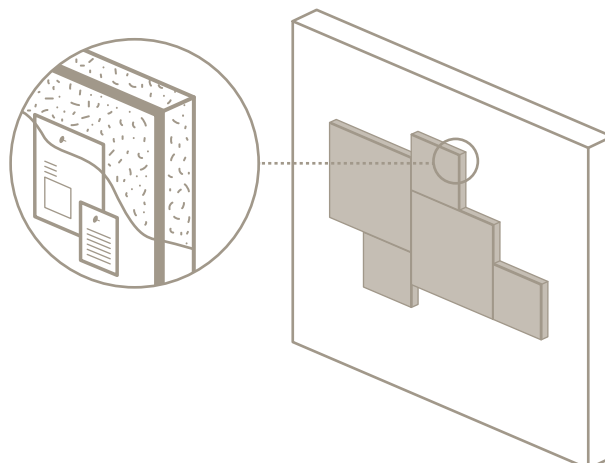

Xorel Textile Options

SOLIDS AND TEXTURES

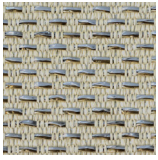

Braid

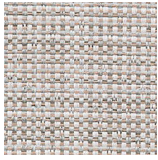

Calabria

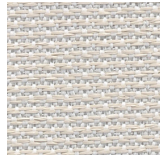

Circuit

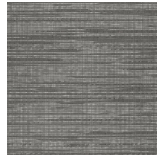

Comet



Cover



Dash



Dover

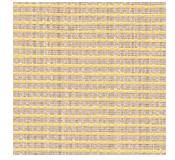

Flash Back



Flux

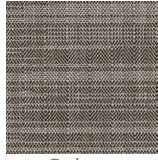

Galway

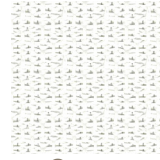

Gamma



Ion



Linen

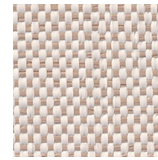

Meteor

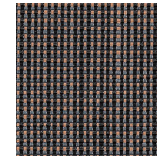

Mojave Matte

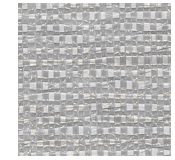

Nexus



Pipeline

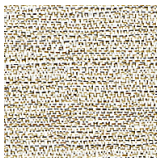

Quarry

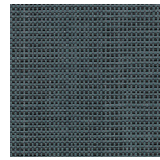

Sahara Matte



Spire



Strie

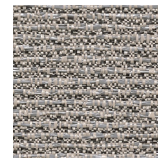

Tangle



Twine

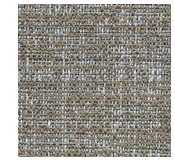

Windsor

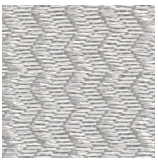

Zipper

JACQUARDS

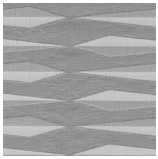

Arrow



Ashford



Haze



Kaleidoscope



Limestone



Nebula

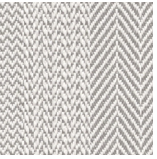

Switch



Trace

EMBOSS AND EMBROIDER



Antoinette
Couture



Axis
Embroider

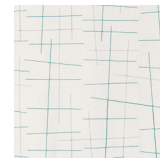

Baja
Embroider

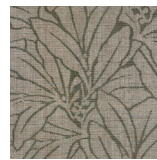

Bloom Emboss

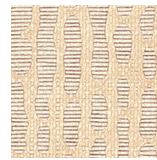

Brigitte
Couture

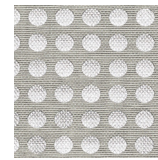

Coco Couture

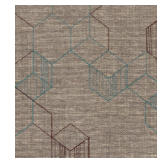

Deco
Embroider



Ellipse
Embroider

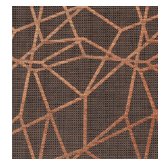

Forge Couture



Fractal
Emboss



Fragment
Emboss



Genome
Embroider

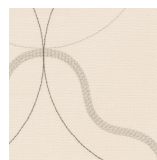

Hoop
Embroider

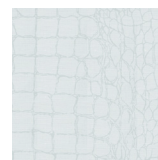

Nile Emboss



Parchment
Emboss

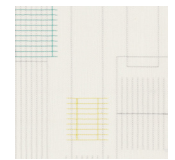

Satellite
Embroider



Silhouette
Embroider

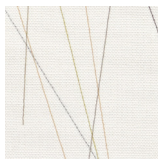

Sleet
Embroider



Switch
Embroider



Veneer Emboss

Install with Ease

WALL MOUNTED INSTALLATION

Fast and easy to install with little disruption or major clean up, Xorel Artform is the optimal solution to address post-occupancy acoustical issues. Panels are lightweight and install simply with a Quick Grab adhesive, 3M Command™ strips or Velcro® fasteners, eliminating the high labor costs associated with rail and hardware systems.

Flush Mounting Options

Quick Grab

Quick Grab adhesive is a VOC-compliant construction adhesive with very low odor for little to no off-gassing. It fits standard caulk guns for easy installation.

Quick Grab Concrete

Xorel Artform can be installed on flat and smooth concrete surfaces with Quick Grab Concrete. Use on highly textured surfaces could potentially result in uneven installation.

3M Command™ Strips

Command Strip install method enables the product to be mounted securely and then removed with no damage to the panels or painted wall. Panels then can be boxed and transported to the next location and mounted again; even in a new configuration.

Velcro® Fasteners

Velcro fasteners are also offered as a flexible mounting option.

To ensure complete customer satisfaction and achieve superior installation results, a Preferred Installer Network of vetted and trained professionals expert in the capabilities, ordering and installation practice of Xorel Artform is available as an added service.



Install with Ease

CEILING MOUNTED INSTALLATION

The ability to horizontally hang panels or panel groupings to reduce reflected sound opens up the opportunities for creative acoustical solutions overhead. Xorel Artform acoustic Quiet-Core™ panels are lightweight and can be flush-mounted onto sheetrock and concrete ceilings or suspended. Suspension mounting in tiled configurations or single panels is simple when ordered with our ready-to-fasten hardware system.

Flush Mounting Options

Quick Grab

Quick Grab adhesive is a VOC-compliant construction adhesive with very low odor for little to no off-gassing. It fits standard caulk guns for easy installation.

Quick Grab Concrete

Xorel Artform can be installed on flat and smooth concrete surfaces with Quick Grab Concrete. Use on highly textured surfaces could potentially result in uneven installation.

Horizontal Suspension

Xorel Artform panels are manufactured with ready-to-fasten hardware for horizontal ceiling suspension. Installation materials, including hanging rods, ceiling plates and joiner strips are included in each box set.

Tiled Suspension: to ensure stability, panels must be suspended in groups of 3 panels or more.

Ceiling plate and rod hardware is paintable, Krylon dual paint-primer spray is recommended. Rod hardware must be primed prior to painting.

Not available in Small size shapes or the Cross shape.



Individually Suspended Panels

Install with Ease

VERTICALLY SUSPENDED BAFFLE INSTALLATION

Vertically suspended ceiling baffles not only open up design possibilities but also allow for sound absorption on both sides for increased sound clarity. Especially suited for large spaces or areas with limited wall space, baffles can be vertically suspended using hanging rods or cables on all ceilings, including drop ceilings.

Suspension Mounting Options

Ceiling Vertically Suspended Baffles Using Cables

Xorel Artform baffles are manufactured with ready-to-fasten hardware for ceiling suspension. Installation materials, including *cables and pendants*, for vertically suspended baffles are included in each box set.

Ceiling Vertically Suspended Baffles Using Rods

Xorel Artform baffles are manufactured with ready-to-fasten hardware for ceiling suspension. Installation materials, including *hanging rods*, for vertically suspended baffles are included in each box set.



Ceiling Vertically Suspended Baffles Using Cables

Drop Ceiling Vertically Suspended Baffles Using Cables

Xorel Artform baffles are manufactured with ready-to-fasten hardware for drop ceiling suspension. Installation materials, including *cables and T-bar clips*, for drop ceiling suspension are included in each box set.

Drop Ceiling Vertically Suspended Baffles Using Rods

Xorel Artform baffles are manufactured with ready-to-fasten hardware for drop ceiling suspension. Installation materials, including *T-bar clips and rod hardware*, for drop ceiling suspension are included in each box set.



Drop Ceiling Vertically Suspended Baffles Using Cables

Install with Ease

VERTICALLY SUSPENDED DUAL-SIDED PARTITION INSTALLATION

Xorel Artform Cascade and Connect provides a bold interior statement that effectively divides open spaces. Especially suited for large spaces or areas with limited wall space, dual-sided partitions can be vertically suspended using cables on all ceilings, including drop ceilings.

Suspension Mounting Options

Ceiling Vertically Suspended Dual-Sided Partitions Using Cables

Xorel Artform Cascade and Connect are manufactured with ready-to-fasten hardware for ceiling suspension. Installation materials, including cables and pendants, for the vertically suspended partitions are included in each box set.



Ceiling Vertically Suspended Partitions Using Cables

Drop Ceiling Vertically Suspended Dual-Sided Partitions Using Cables

Xorel Artform Cascade and Connect are manufactured with ready-to-fasten hardware for drop ceiling suspension. Installation materials, including cables and T-bar clips, for drop ceiling suspension are included in each box set.



Drop Ceiling Vertically Suspended Partitions Using Cables

Hardware for Cascade

Cables and pendants connect the baffles vertically with pre-attached tabs. Available in silver, white or black finish.



Hardware for Connect

Acorn nuts and 0.5" studs connect the baffles horizontally and vertically with pre-attached tabs. Available in silver, white or black finish.

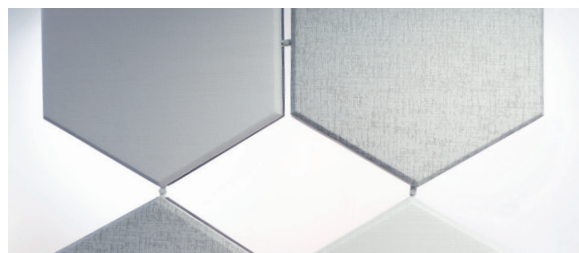

Install with Ease

INSTALLATION CHART

	Wall Mounted	Ceiling Mounted	Ceiling Horizontally Suspended—Tiled	Ceiling Horizontally Suspended—Individual	Ceiling Vertically Suspended Baffles	Ceiling Vertically Suspended Cascade	Ceiling Vertically Suspended Connect
Arc							
Small	•	•					
Medium	•	•	•				
Large	•	•	•				
Circle + Circle 3D							
Small	•	•					
Medium	•	•	•	•			•
Large	•	•	•	•	•	•	
X-Large	•	•	•	•	•		
2X-Large	•	•	•	•	•		
3X-Large	•	•	•	•	•		
Mounted Kit / 2(S), 2(M), 1(L), 1(XL)	•	•					
Horizontal Suspended Ceiling Kit / 2(M), 2(L), 1(XL), 1(2XL)	•	•	•	•			
Vertical Suspended Ceiling Kit / 2(L), 2(XL), 1(2XL), 1(3XL)					•		
Criss							
Small	•	•					
Medium	•	•	•				
Large	•	•	•	•			
Cross							
Small	•	•					
Medium	•	•					
Large	•	•					
X-Large	•	•					
Diamond + Diamond 3D							
Small	•	•					
Medium	•	•	•				
Large	•	•	•	•	•	•	•
X-Large	•	•	•	•	•		
2X-Large	•	•	•	•	•		
Flip							
Large	•	•	•	•	•	•	
X-Large	•	•	•	•	•		
2X-Large	•	•	•	•	•	•	
3X-Large	•	•	•	•	•		
Hex + Hex 3D							
Small	•	•					
Medium	•	•	•	•			•
Large	•	•	•	•	•	•	
X-Large	•	•	•	•	•		
2X-Large	•	•	•	•	•		
3X-Large	•	•	•	•	•		

	Wall Mounted	Ceiling Mounted	Ceiling Horizontally Suspended—Tiled	Ceiling Horizontally Suspended—Individual	Ceiling Vertically Suspended Baffles	Ceiling Vertically Suspended Cascade	Ceiling Vertically Suspended Connect
Peak							
Small	•	•					
Medium	•	•	•				
Large	•	•	•				
X-Large	•	•	•				
Plank							
Small	•	•					
Large	•	•	•				
Ridge							
Small	•	•					
Medium	•	•					
Large	•	•					
X-Large	•	•					
2X-Large	•	•					
3X-Large	•	•					
Ripple							
Kit / 1 row 6 panels	•	•			•		
Square + Square 3D							
Small	•	•					
Large	•	•	•	•			
Scale							
Small	•	•					
Medium	•	•	•				
Large	•	•	•	•			
Tall Hex							
Small	•	•					
Medium	•	•	•				
Large	•	•	•	•			
Valley							
Small	•	•					
Medium	•	•					
Large	•	•					
X-Large	•	•					
Waveline + Waveline 3D							
Small	•	•					
Medium	•	•	•	•			
Large	•	•	•	•			

Specifications

BOX SETS

Xorel Artform is priced and sold in box sets of the same shape, size, substrate, fabric and color. Each box arrives to the job site securely packed and includes all installation and adhesive materials.

Ceiling Horizontal Suspension hardware is sold separately.

Fast Delivery: 4-8 week lead time.

Standard

3-6 panels/box

3D

3-4 panels/box

Baffle

3-6 baffles/box

Minimum order is 1 box.

Dimensional Orientation

Box sets of Hex, Waveline, and Square 3D panels include "handed" shapes which feature the dimensional element oriented towards either right or left. This attention to detail ensures that the specified Xorel fabric weave is wrapped along the panel in the same direction so that fit and finish are not compromised when changing panel orientation. Two of each handed shape are included in each box set.



Warranty

5 YEAR WARRANTY

We warranty Xorel Artform panels for a period of 5 years from purchase date. Any Xorel Artform panels that are defective in workmanship or materials (3M command strips, adhesive, velcro or ceiling suspension hardware*) will be replaced at no charge. The warranty does not cover:

(a) ordinary wear and tear; (b) damaged caused by mold or mildew; (c) unacceptable temperature/humidity variation; (d) improper use; (e) improper maintenance; (f) improper storage or handling; (g) any other damage or problem due to external causes unrelated to any Carnegie Fabric product defect.

*Correct installation method must be used for warranty to be in force. Panels must be used within standard industry limitations.

